

---

# Wheel Balancer Manual

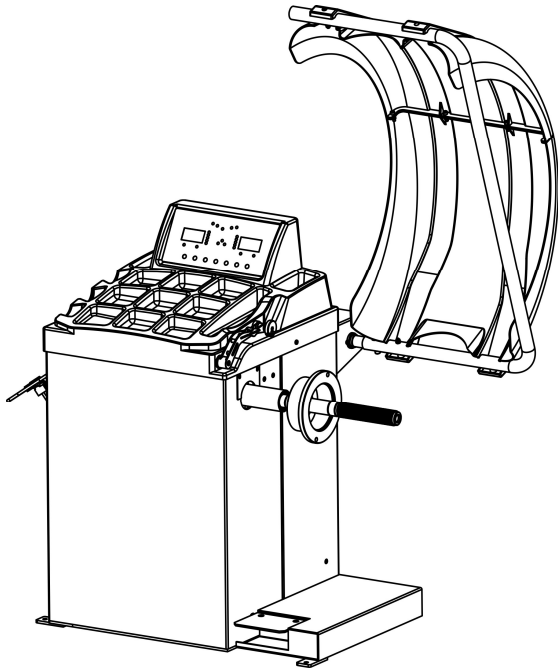





### **Warning**

- This manual is a necessary part of the product. Please read carefully.
- Keep the manual for later use when maintaining the machine.
- This machine can only be used for the designated purposes. Never use it for any other purpose.
- The manufacturer is not responsible for the damage incurred by improper use or use other than the intended purpose.

### **Precaution**

- The equipment can only be operated by qualified personnel with special training. Modification to any components or parts, or use the machine for other purpose without either obtaining the agreement from the producer, or observing the requirement of the instructions may lead to direct or indirect damage to the equipment.
  - ★ The equipment should be installed on the stable ground, not wooden pallet, otherwise not accurate.
- Keep the back panel 0.6M away from the wall for good ventilation. Enough room should be left on both sides for convenient operation.
- Do not put the equipment a place with high temperature or moisture, or near the heating system, water tap, air-humidifier or chimney.
  - Avoid lots of dust, ammonia, alcohol, thinner or spraying binder.
  - People who are not operating the machines should be kept away when it is used.
  - Use appropriate equipment and tools, protective and safety equipment, including eyeglasses, earplugs and working boots.
- Pay special attention to the marks on the machine.
- Do not touch or approach the moving parts by hand during operating.
- Do not remove the safety device or keep it from working properly.

## Contents

---

1. General-----	1
2. Machine assembly-----	1
3. Controls and components-----	3
4. Indication and use of wheel balancer-----	6
5. Self-calibration of wheel balancer -----	10
6. Errors-----	11
7. Self-diagnoses-----	12
8. Setting machine-----	12
9. OPT function -----	13
10. Spare parts list and Exploded drawings-----	15

# 1. General

## 1.1. Technical data:

- Max wheel weight: 65kg
- Power: 0.2kw;0.37kw
- Power supply: 220v;230v;240v;110v;50hz;60hz
- Balancing accuracy: 1g
- 8 balancing modes: DYN, ALU1, ALU2, ALU3, ALU4,ALU5,ALUS, ST
- Balancing speed: 200r/min
- Cycle time: 8s
- Rim diameter: 10 " ~24 " (256mm~610mm)
- Sound pressure level during work cycle: <70db
- 

## 1.2. Features:

- Statistic and dynamic balancing, ALU-programs for alloy rims or special shaped
- Self diagnoses, easy to find the problem
- Apply to steel and aluminum alloy rim

## 1.3. Working environment:

- Temperature: 5~50℃
- Height: ≤4000m

# 2. Machine assembly

## 2.1. Unpack

Unpack the carton, check if missing any spare parts.

No.	Item	Qty
1	Width gauge	1
2	Conic No.1	1
	Conic No.2	1
	Conic No.3	1
	Conic No.4	1
3	Quick release nut	1
4	Thread hub	1
5	Bowl for quick nut	1
6	Pad for bowl	1
7	Balancing hammer	1
8	100g weight	1
9	Allen wrench	1

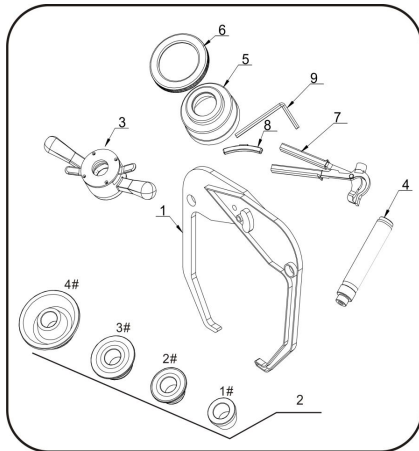

---

## 2.2. Install

- The equipment should be installed on the stable ground, not wooden pallet, otherwise not accurate.
- Keep the back panel 0.6M away from the wall for good ventilation. Enough room should be left on both sides for convenient operation.

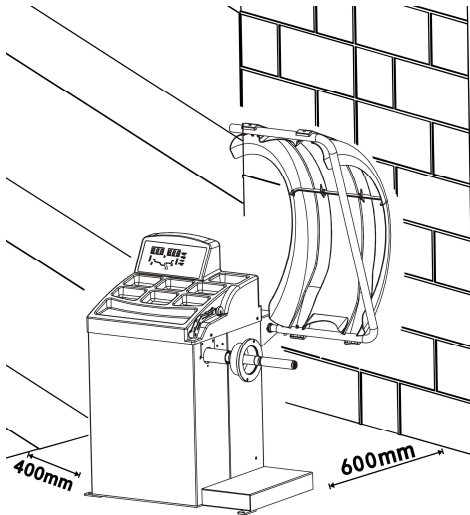

2.3. Fix balancer to floor with screws on the bottom.

2.4. Install adaptor

The wheel balancer is supplied complete with cone type adaptor for fastening wheel with central bore. (see below picture)

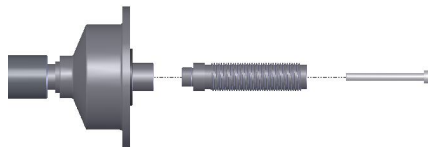

2.5. Install wheel

Clean wheel, take off counterweights, check pressure of wheel.

Choose the way of installation according to the type of wheel.



Main shaft-wheel—  
suitable cone( small head towards inside)—quick handle nut

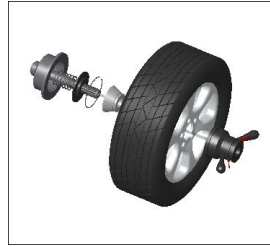

Main shaft-suitable cone(big head towards inside)  
—wheel—quick handle nut

**Attention:** May add a wheel, and hold the wheel to help install the thread hub. When installing or taking off wheel, do not let wheel move on the shaft, to avoid scratching shaft.

### 3. Controls and components

No.	Item	Standard/Optional
A	Switch	S
B	Head with tool tray	S
C	Gauge head	S
D	Main shaft	S
E	Pedal breaker	O
F	Safe guard	S
G	Key board	S

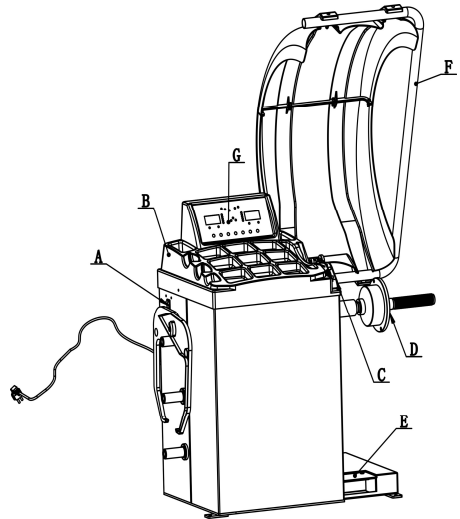





## Display plate (G)





- 1.inside unbalance value digital display
- 2.inside unbalance position display
- 3.outside unbalance value digital display
- 4.outside unbalance position display
- 5.displays showing type of correction chosen.







### Eight balancing modes

Icon	Balancing mode	Operation	Add weights
 <b>DYN</b>	Standard/Default	<ol style="list-style-type: none"> <li>1. Turn on machine</li> <li>2. Input a,b,d value</li> <li>3. Start spin, after spin stop</li> </ol>	Clip on weights on both sides of rim edge
 <b>ALU-1</b>	ALU1	<ol style="list-style-type: none"> <li>1. Turn on machine</li> <li>2. Input a,b,d value</li> <li>3. Press ALU button, indicator lit up</li> <li>4. Start spin, after spin stop</li> </ol>	Add adhesive weights on the rim shoulder both sides
 <b>ALU-2</b>	ALU2	<ol style="list-style-type: none"> <li>1. Turn on machine</li> <li>2. Input a,b,d value</li> <li>3. Press ALU button, indicator lit up</li> <li>4. Start spin, after spin stop</li> </ol>	Clip on weight on inside rim edge, add adhesive weight on outside rim shoulder
 <b>ALU-3</b>	ALU3	<ol style="list-style-type: none"> <li>1. Turn on machine</li> <li>2. Input a,b,d value</li> <li>3. Press ALU button, indicator lit up</li> <li>4. Start spin, after spin stop</li> </ol>	Add adhesive weights on the rim shoulder both sides
 <b>ALU-4</b>	ALU4	<ol style="list-style-type: none"> <li>1. Turn on machine</li> <li>2. Input a,b,d value</li> <li>3. Press ALU button, indicator lit up</li> <li>4. Start spin, after spin stop</li> </ol>	Clip on weight on inside rim edge, add adhesive weight on outside rim shoulder



 <b>ALU-5</b>	ALUS	<ol style="list-style-type: none"> <li>1. Turn on machine</li> <li>2. Input a,b,d value</li> <li>3. Press ALU button, indicator lit up</li> <li>4. Start spin, after spin stop</li> </ol>	Add adhesive weight on inside rim shoulder, clip on weight on outside rim edge
 <b>ALU-S</b>	ALUS	<ol style="list-style-type: none"> <li>1. Turn on machine</li> <li>2. Press ALU button, indicator lit up</li> <li>3. Input aI,aE,d value</li> <li>4. Start spin, after spin stop</li> </ol>	Add adhesive weights on the two positions gauge head touch
 <b>ST</b>	Static mode, for motorcycle wheels	<ol style="list-style-type: none"> <li>1. Turn on machine</li> <li>2. Input a,b,d value</li> <li>3. Press ALU button</li> <li>4. Start spin, after spin stop</li> </ol>	Add adhesive weight

#### Key board (H)

Icon	Function	Icon	Function
	Rim data		Selection of "ALU" modes
	Data add key		Unbalance display pitch and threshold
	Data reduction key		Start
	Stop/Cancel		

## 4. Indication and use of wheel balancer

### 4.1. DYN (Standard/Default) mode

4.1.1. Clean wheel, take off counterweights, check pressure of wheel. Choose the way of installation according to the type of wheel.



Main shaft-wheel—  
suitable cone( small head towards inside)—quick handle nut

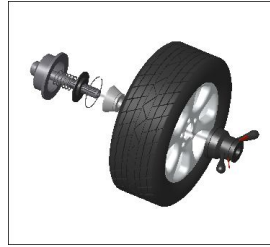



Main shaft-suitable cone(big head towards inside)  
—wheel—quick handle nut



**Attention: May add a wheel, and hold the wheel to help install the thread hub. When installing or taking off wheel, do not let wheel move on the shaft, to avoid scratching shaft.**



4.1.2. Turn on machine



4.1.3. Input a b d value

Turn on machine, choose right way to install wheel according to the type of wheel. Set “a” “b” “d” values:

- set “a” value: move the gauge to measuring position as illustrated as Fig.1, hold the gauge still in position for approx. 4 seconds, successful memorization is given, then return the gauge to position 0.(The value measured in automatic mode appear on the display). Or press  and  and  to set manually.

0.(The value measured in automatic mode appear on the display). Or press  and  and  to set manually.

- set “b” value: set nominal diameter “b” marked on the wheel or use the width gauge to measure the value of “b” as Fig.2, then press  and  and  to set manually.

- set “d” value: this value measured in automatic mode same time as “a” value setting, or press  and  and  to set manually.

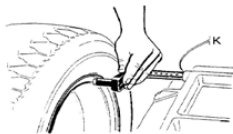

Fig.1

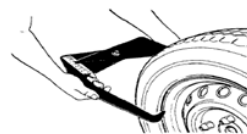



Fig.2

4.1.4. Put down the guard and press  to perform a measuring spin.

4.1.5. In a few seconds the wheel is brought to operating speed and begin measuring unbalance, the unbalance values remain on instruments 1 and 3 when the wheel stopped. Press  may check the real unbalance value under threshold.

4.1.6. Anticlockwise moving wheel slowly, until the right LED lit up full, clip weight on 12 o'clock position (Fig.3)

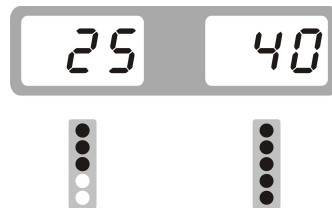
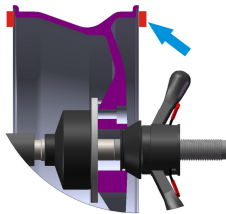

Fig. 3

4.1.7. Anticlockwise moving wheel slowly, until the left LED lit up full, clip weight on 12 o'clock position (Fig.4)

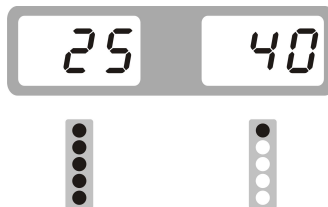
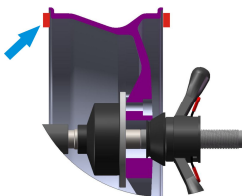

Fig. 4

4.1.8. After finishing clipping the counterweights, put down the guard or press  , to perform balancing spin again, if comes out 00 00, means balancing succeed. (Fig.5)



Fig. 5

## 4.2. ALU-1 mode (ALU-1, ALU2 same operation, only the position to add weights different)

4.2.1. Set "a" "d" "b" values

4.2.2. Press  until ALU1 indicator lit up

4.2.3. Put down the guard and press  to perform a measuring spin.

4.2.4. In a few seconds the wheel is brought to operating speed and begin measuring unbalance, the unbalance values

remain on instruments 1 and 3 when the wheel stopped. Press  may check the real unbalance value under threshold.

4.2.5. Anticlockwise moving wheel slowly, the displays with right LED's lit up full indicate the correct angular position where to mount the counterweights, 12 o'clock position outside, as Fig.6, add the counterweight.

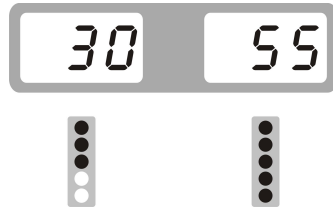
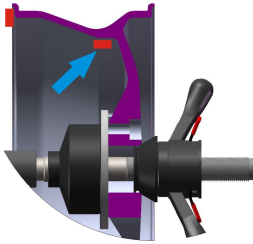

Fig. 6

4.2.6. Anticlockwise moving wheel slowly, the displays with left LED's lit up full indicate the correct angular position where to mount the counterweights, 12 o'clock position inside, as Fig.7, add the counterweight.

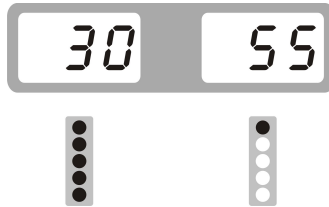
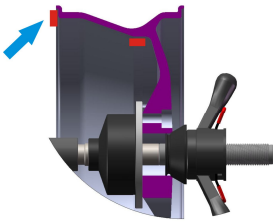

Fig. 7

4.2.7. After finishing mounting the counterweights, put down the guard and press , to perform balancing spin again, if comes out 00 00, means balancing succeed. (Fig.8)















Fig. 8

### 4.3. ALU—S mode

**This mode is used for special rim, if ALU1/ALU2 can not be used, you should choose ALUS mode.**

Input aI, aE, d value

- Set "aI": pull gauge out let the gauge head touch the position of FI for 4 seconds, may press  and  and  to change
- Set "aE": pull gauge out let the gauge head touch the position of FE for 4 seconds, may press  and  and  to change
- Set "dI": read from rim, may press  and  and  to change
- Set "dE": read from rim, may press  and  and  to change

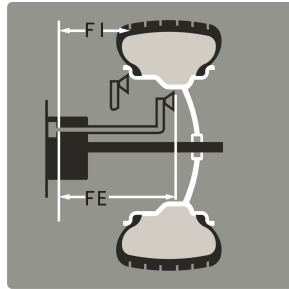

Fig. 9

Put down the guard and press  to perform a measuring spin.

4.3.1. 12 o'clock position to add weight

Set SLC as OFF according to 8.1

Anticlockwise moving wheel slowly, until the right LED lit up full, add weight on 12 o'clock position (Fig.10)

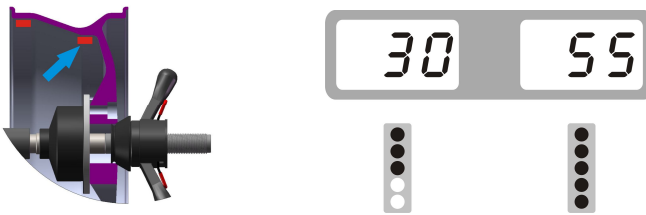

Fig. 10

Anticlockwise moving wheel slowly, until the left LED lit up full, add weight on 12 o'clock position (Fig.11)

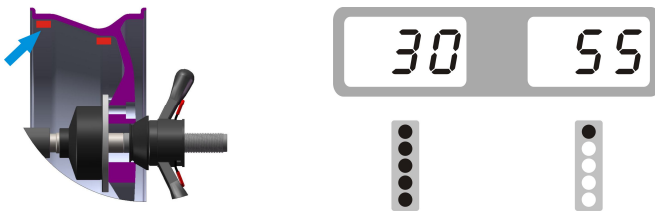

Fig. 11

After finishing mounting the counterweights, put down the guard and press , to perform balancing spin again, if comes out 00 00, means balancing succeed. (Fig.12)



Fig. 12

4.3.2. Use gauge head to add weight

Set SLC as ON according to 8.1



Fig. 13

Anticlockwise moving wheel slowly, until the right LED lit up full (Fig.14)



Fig. 14

Take off proper counterweight to be hold by the gauge head as Fig. 16

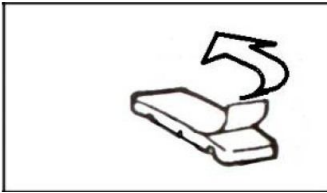

Fig. 15

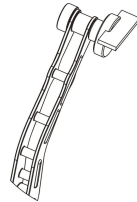

Fig. 16

Pull out gauge until there is a square comes in the middle window (Fig. 17)



Fig. 17

Release the counterweight and let it stick on rim (Fig. 18)

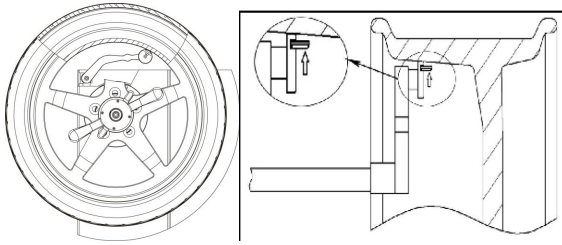

Fig. 18

Anticlockwise moving wheel slowly, until the left LED lit up full (Fig.19)



Fig. 19

Take off proper counterweight to be hold by the gauge head as Fig. 16

Pull out gauge until there is a square comes in the middle window (Fig. 20)



Fig. 20

Release the counterweight and let it stick on rim (Fig. 21)

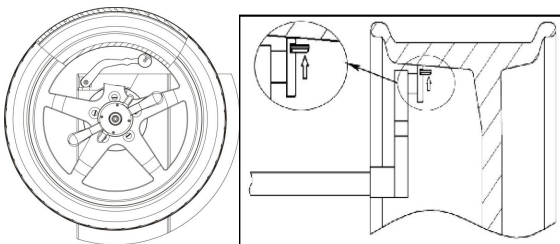

Fig. 21

Then turn down safe guard and press  to start spin, comes Fig. 22 means the wheel is balanced.



Fig. 22

### 3. 4 ALUS split function

Note: Only ALU-S mode can use this function. And Operator must be experienced.

1	In the case of the ALU-S mode, press	comes>	
2	Through the  and  input wheel number, then press	comes>	
3	Keep the next spock( either direction is ok) on the position of 12 o'clock, press	comes>	
4	Anticlockwise rotate wheel by hand slowly, until the outside SP1 LED lit up full, add the adhesive weight (to stick the weights on position of 12 o'clock or else depends SLC=On or Off)	comes>	
5	Anticlockwise rotate wheel by hand slowly, until the outside SP2 LED lit up full, add the adhesive weight (to stick the weights on position of 12 o'clock or else depends SLC=On or Off)	comes>	
6	Put down safe guard and press  , after spin stop		
Successful operation			

## 5. Self-calibration of wheel balancer





### 5.1. Self-calibration of wheel balancer

5.2.Turn on balancer, install a medium size wheel (14"-18")which can use clip-on weight, set "a b d" value, then











Do the self-calibration whenever you think the balancer is not accurate. The 100g weight must be accurate.

Step 1	Press  and hold, then press	comes	
Step 2	Put down safe guard or press  start spin, after spin stop	comes	





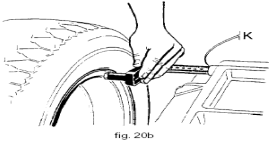



Step 3	Open the safe guard and clip a 100 gram weight on the outside 12 o'clock position, put down safe guard and press  to start spin, after spin stop	comes	
Step 4	Open the safe guard and clip a 100 gram weight on the inside 12 o'clock position, put down safe guard and press  to start spin, after spin stop	comes	
self-calibration finished			

### 6. Rim distance gauge calibration

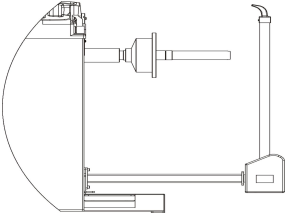

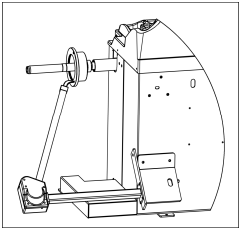
	comes >	
pull gauge to position "0" and hold, press 	comes >	
pull gauge to position "15" and hold, press 	comes >	
Set "d" by press  and  , (for example if it is 16 inch, make it 16)	comes >	
move gauge to touch the edge of rim and keep still 	>	press 
comes >		
self-calibration finished		

### 7. 1 Width gauge calibration (if provided)

1		comes >	
2		explain >	Keep width ruler as position
3	Press 	comes >	
4		explain >	Press 
5		explain >	Width gauge calibration finished

## 8. Errors

Various abnormal conditions can arise during machined operation by the microprocessor, if comes the errors, must stop operation, find the reason and the solution according, if the error persists, consult the supplier.

No.	Errors	Reasons	Solution
1		1. No spin 2. Shaft spin	1. If no spin, check or change power board 2. If spin, check or change position pick up board and computer board 3. Adjust position pick up board support
2		1. No wheel or wheel not locked tightly 2. Position pick up board problem	1. Lock tightly 2. check or change position pick up board

3		1. No enough pressure in wheel 2. Wheel distortion	1. Add proper pressure in wheel 2. Check wheel
4		1.Position pick up board problem 2. Computer board problem	1.Check or change position pick up board 2.Check or change computer board
5		1. Micro switch problem 2. Computer board problem	1.Check or change Micro switch 2.Check or change computer board
6		1. Power board problem 2. Computer board problem	1.Check or change power board 2.Check or change computer board
7		1. Program lost 2. Computer board problem	1.Self calibration 2. Check or change computer board
8		1. No add 100g weight during self calibration 2. Computer board problem 3. Power board problem	1. Add 100g weight 2.Check or change computer board 3.Check or change power board
9		1. Micro switch problem 2. Computer board problem	1.Check or change micro switch 2.Check or change computer board
10		1. Computer board problem 2. Power board problem	1.Check or change computer board 2.Check or change Power board

### 9. Self- diagnoses

Press and hold, then press goest to self diagnoses, press to next , press to escape

Order	Display	Function	Function normal
1		Display	All lit up
2		Position pick up board	POS changes in 0-127
3		Distance potentiometer	Left window data is 327-340, when pull gauge out, the data changes
4		Diameter potentiometer	left window data is 327-340, turn ruler to another direction, data changes

5		Width potentiometer	left window data is 327-340, turn ruler to another direction, data changes
6		Pressure sensor	Use hand to press main shaft, 4X-4X 6X-6X changes

## 10. Setting machine

### 10.1. Machine setting

Press and hold, then press goes to set machine, press and to change, press to next

Order	Display	function	choice
1		Unbalance display threshold	5/10/15
2		Sound	On/off
3		Light	1-8
4		When ALU-S mode if use gauge head to add weight	OFF: 12 o'clock position, no use of gauge head to add weight ON: Use gauge head to add weight
5		Tire weight	On/off
6		Safe guard	ON: Put down safe guard to start spin OFF: Put down safe guard then press start to start spin

### 10.3 Unit of weight setting

Press to set safe guard

Display	Function	Explain
	Unit of weight	Gram
	Unit of weight	Ounce

#### 10.4 mm / inch unit set





★ Press  +  to set safe guard



Display	Function	Explain
	inch	Diameter and width are displayed in inches
	mm	Mm diameter and width

### 11. OPT function

**Note: When unbalance value is too much, choose OPT, and operator must be experienced.**

Install wheel, input a b d value

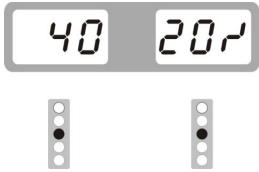
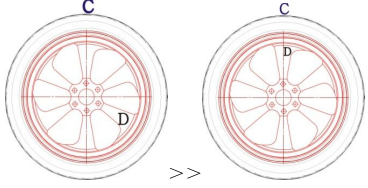
1	Press  + 	comes >	
2	Put down safe guard and press 	comes >	
3	With the help of tire changer, change the rim and rubber 180 degree	reference >	
4	Then put down safe guard and press 	comes >	
5	Rotate wheel until four indicators lit up (two on both sides, the dark spot in the right side picture), mark the positon C with chalk on rubber	reference >	

6	Rotate wheel until two indicators lit up (one on both sides, the dark spot in the right side picture), mark the position D with chalk on rim	reference >	
7	With the help of tire changer, change the rim and rubber to make C and D match	reference >	
8	Put down safe guard and press 	comes >	If unbalance is less than before, OPT succeed

## 12. Spare parts list and Exploded drawings

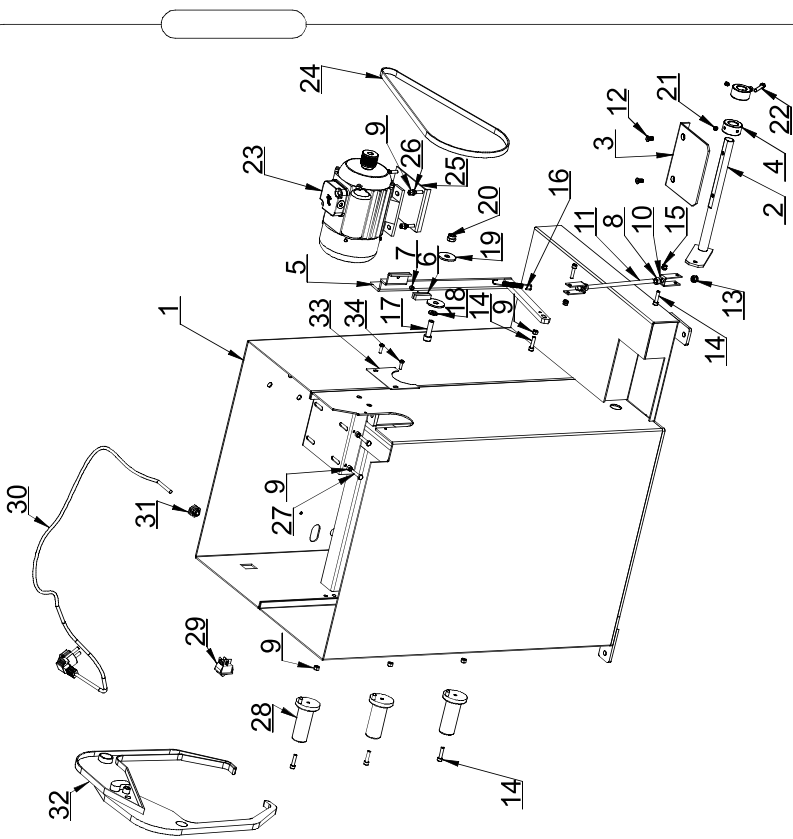

2016/0502  
1

ITEM	DESCRIPTION	PART NO	QTY
1	Body	2066019	1
2	Foot lever	2064939	1
3	Brake pedal	2064962	1
4	Brake ring	2064941	2
5	Brake lever	2064944	1
6	Brake pads	3005142	1
7	Hex nut GB41 /M5	6000125	1
8	Hex nut GB41 /M8	6000127	2
9	Hex nut GB41 /M6	6000309	11
10	Connecting	2064942	2
11	Connecting rod	2064955	1
12	Bolt GB2673 M6X12	6000417	2
13	Hex nut GB889-M8	6000148	2
14	Bolt GB70/M6X25	6000294	6
15	Hex nut GB889/M6	6000233	2
16	Tension spring	2010701	1
17	Bolt GB70/M10X60	6000289	1
18	Flat washer Φ10	6000134	1
19	Flat washerΦ38x10x3	2037401	2
20	Hex nut GB889 M10	6000143	1
21	Bolt GB80/M6X12	6000230	2
22	Bolt GB70/M6X35	6000207	1
23	Motor MY6324	4003001	1
24	Belt 380J5	6000171	1
25	Fixed seat	2034501	1
26	Flat washerΦ6	6000138	4
27	Bolt GB70/M6X35	6000120	2
28	Holder	2034301	3
29	Power Switch	4000801	1
30	Plug	4001901	1
31	Cable glands	4000901	1
32	Calliper	3005056	1
33	Small Side plate	2043601	1
34	Bolt GB818 M6*16	6000271	2

ITEM NO	DESCRIPTION	PART NO.	Q'TY
1	Screw M10X160	6000201	1
2	Flat washer GB95/φ10	6000134	6
3	Horizontal screw M10X160	6000176	1
4	Pressure sensor	4001701	2
5	Spring washer GB93/φ10	6000197	3
6	Spring washer GB93φ30x10x3	2052501	1
7	Spring washer GB93φ38x10x3	2037401	1
8	Screw GB5783 M10X25	6000184	2
9	Complete axle	2032901	1
10	Bolt GB818/M4X10	6000267	4
11	Thread hub	2042201	1
12	Belt GB70/M10X160	6000259	1
13	Tower spring	2042801	1
14	Plastic lid	3005013	1
15	Conic NO. 1	2033401	1
16	Conic NO. 2	2033501	1
17	Conic NO. 3	2033601	1
18	Conic NO. 4	2033701	1
19	Hex nut GB41 M10	6000336	5
20	Copper backing	6000159	4
21	Allen wrench	6000169	1
22	Retaining ring	2067389	1
23	Support	2034001	1
24	Position pick-up board	5000401	1

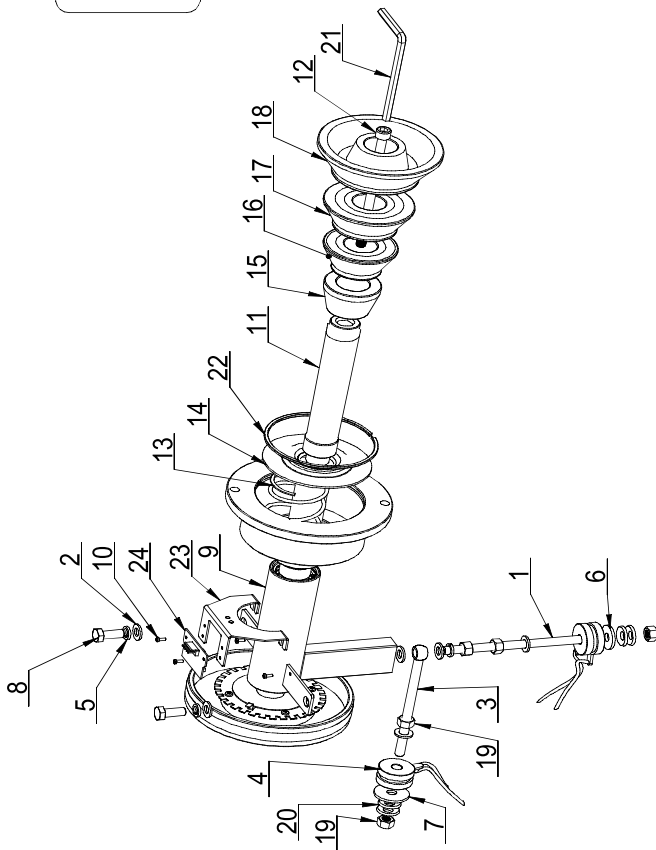



ITEM NO	DESCRIPTION	PART NO.	Q'TY
1	Sleeve	2064812	1
2	Slide bearing	2064398	1
3	Support	2067562	1
4	Aluminum ruler rod	2046301	1
5	Footage number	5001388	1
6	Circuit board-support	2067563	1
7	Distance pick-up board	2067439	1
8	Potentiometer RV24/202	4004471	1
9	Complete ruler head	2065780	1
10	Potentiometer support	2066172	1
11	Grating ruler	2067437	1
12	Bolt M3X10	6000375	1
13	Hex nut GB41_M3	6000124	1
14	Bolt GB845 ST4_2X16	6000160	2
15	Bolt GB880_M6X12	6000230	2
16	Bolt GB70_M6X20	6000114	1
17	Bolt GB818M5*16	6000271	2
18	Tension spring	2034401	1

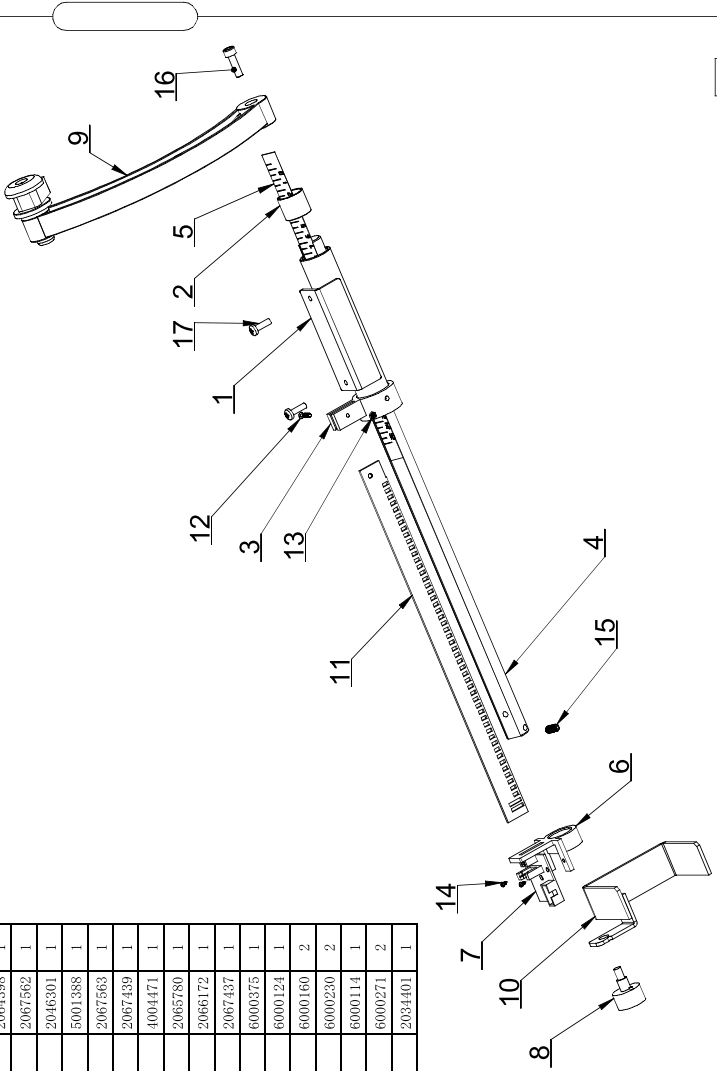

ITEM NO	DESCRIPTION	PART NO.	Q'TY
1	Fixed plate	2064782	1
2	Electric power board	5001321	1
3	Support	4004380	4
4	Resistor	5001350	1
5	Bolt GB818 M5X16	6000271	2
6	Hex nut GB41 M5	6000125	2

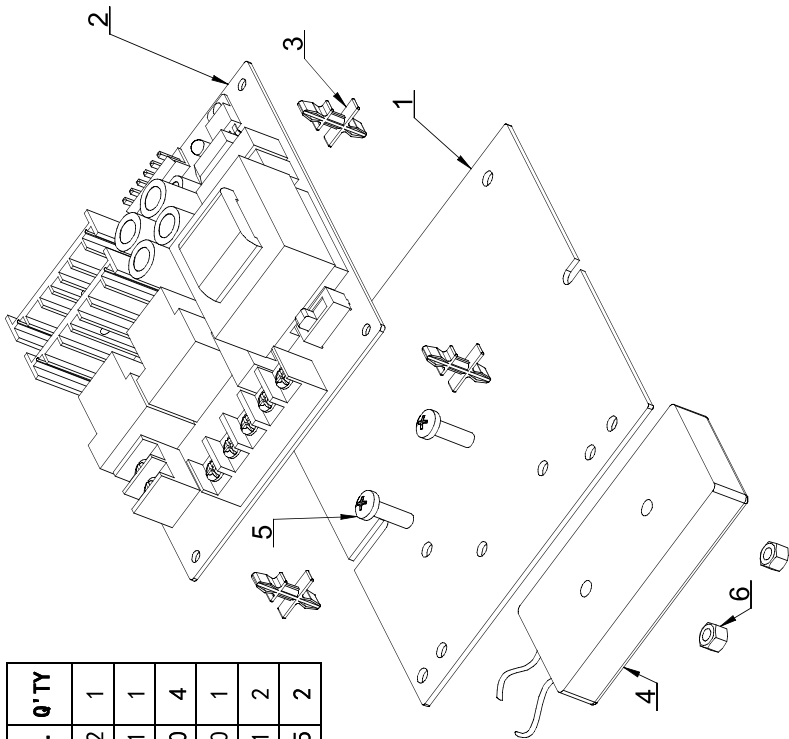

ITEM NO	DESCRIPTION	PART NO.	Q'TY
1	2#/Head with Tools Tray	3005248	1
2	Fix Plate	2065290	1
3	Computer bard	5001319	1
4	Display mask	5001378	1
5	Bolt GB819/M3X10	6000375	5
6	Bolt GB818/ M5X16	6000271	2

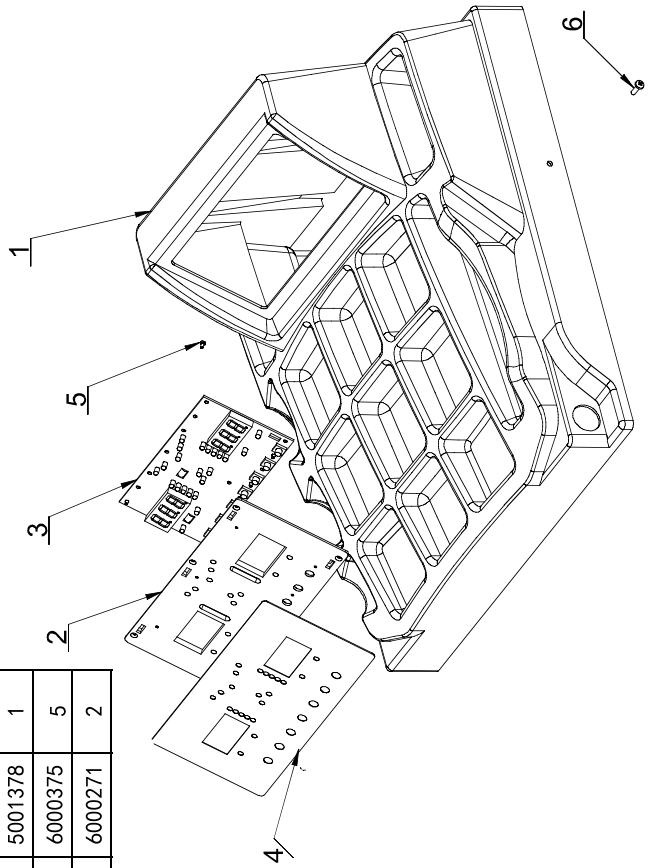

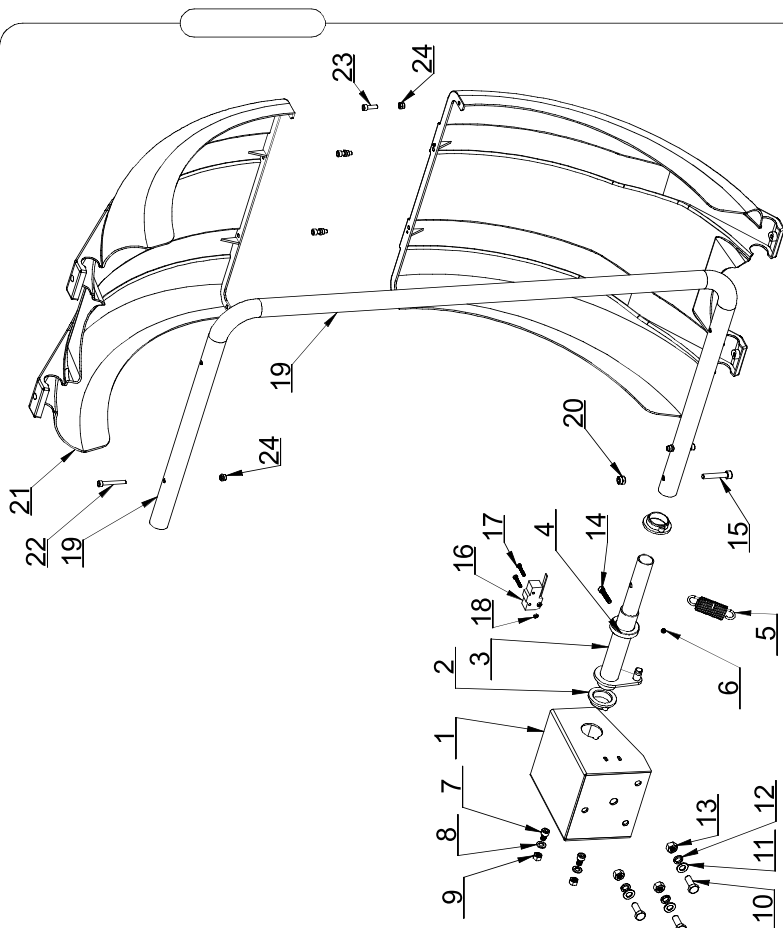

ITEM NO	DESCRIPTION	PART NO.	Q'TY
1	Protection box	2043701	1
2	Plastic ferrule	3002301	2
3	Shaft	2036601	1
4	Ferrule	2034201	1
5	Tension spring	2053501	1
6	Bolt GB80 M6X10	6000130	1
7	Bolt GB70 M6X20	6000102	2
8	washer GB95-Ø8	6000142	2
9	Hex nut GB41 M8	6000127	2
10	Screw GB5783 M10X25	6000184	3
11	washer GB95-Ø10	6000134	3
12	Spring washer GB93-Ø10	6000197	3
13	Hex nut GB41 M10	6000123	3
14	Bolt GB5783 M6X35	6000207	1
15	Bolt GB70 M6X45	6000435	1
16	Micro switch	4004436	1
17	Bolt GB818 M4X30	6000430	2
18	Hex nut GB41 M4	6000341	2
19	Bend pipe	2033301	1
20	Hex nut M8	6000127	1
21	Plastic cover (Ø716)	3002501	2
22	Bolt GB70 M6X45	6000435	2
23	Bolt GB70 M6X20	6000114	4
24	Hex nut M6	6000309	6

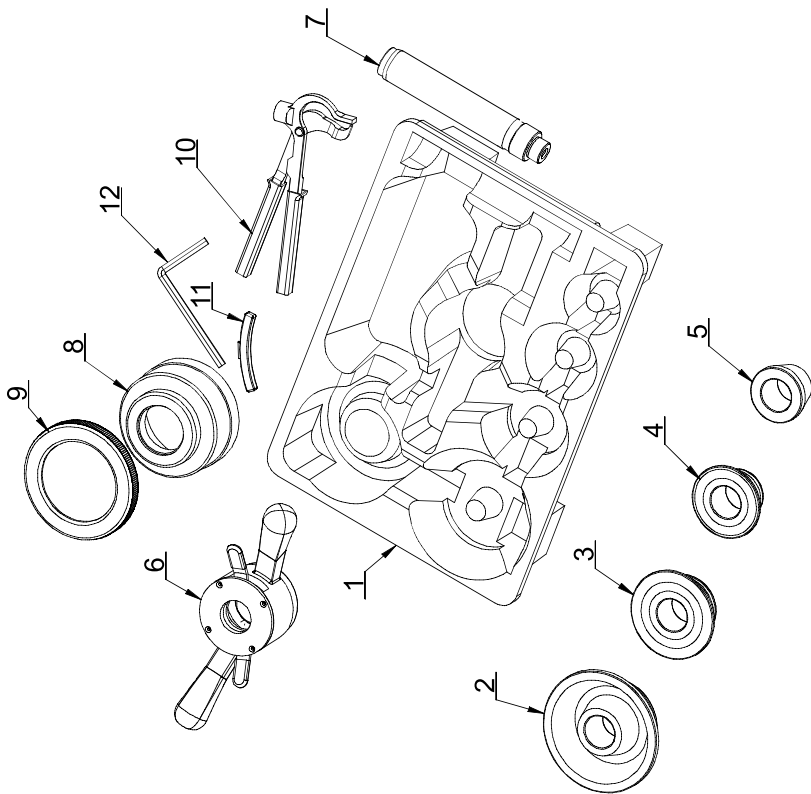

ITEM NO	DESCRIPTION	PART NO.	Q' TY
1	Package box	7000114	1
2	Conic 4	2033701	1
3	Conic 3	2033601	1
4	Conic 2	2033501	1
5	Conic 1	2033401	1
6	Locking nut	2042901	1
7	Thread rod	2042201	1
8	Plastic bowl	3005018	1
9	Rubber buffer	3005019	1
10	Hammer	4003601	1
11	Counterweight	6000210	1
12	Spanner	6000169	1

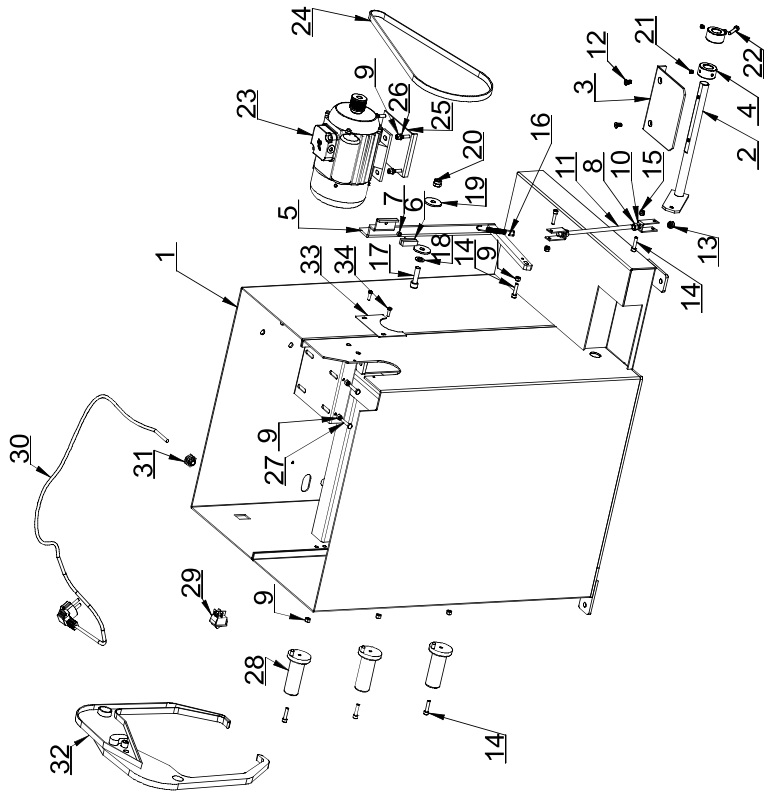

ITEM	DESCRIPTION	PART NO	Q'TY
1	Body	2066019	1
2	Foot lever	2064939	1
3	Brake pedal	2064962	1
4	Brake ring	2064941	2
5	Brake lever	2064944	1
6	Brake pads	3005142	1
7	Hex nut GB41 /M5	6000125	1
8	Hex nut GB41 /M8	6000127	2
9	Hex nut GB41 /M6	6000309	11
10	Connecting rod	2064942	2
11	Connecting rod	2064955	1
12	Bolt GB2673 M6X12	6000417	2
13	Hex nut GB889-M8	6000148	2
14	Bolt GB70/M6X25	6000294	6
15	Hex nut GB889/M6	6000233	2
16	Tension spring	2010701	1
17	Bolt GB70/M10X60	6000289	1
18	Flat washer Φ10	6000134	1
19	Flat washer Φ38x10x3	2037401	2
20	Hex nut GB889 M10	6000143	1
21	Bolt GB80/M6X12	6000230	2
22	Bolt GB70/M6X35	6000207	1
23	Motor MY6324	4003001	1
24	Belt 380J5	6000171	1
25	Fixed seat	2034501	1
26	Flat washer Φ6	6000138	4
27	Bolt GB70/M6X35	6000120	2
28	Holder	2034301	3
29	Power Switch	4000801	1
30	Plug	4001901	1
31	Cable glands	4000901	1
32	Caliper	3005056	1
33	Small Side plate	2043601	1
34	Bolt GB818 M5*16	6000271	2

2016/0502 1

ITEM NO	DESCRIPTION	PART NO.	Q'TY
1	Screw M10X160	6000201	1
2	Flat washer GB95/Φ10	6000134	6
3	Horizontal screw M10X160	6000176	1
4	Pressure sensor	4001701	2
5	Spring washer GB93/Φ10	6000197	3
6	Spring washer GB93 Φ30×10×3	2052501	1
7	Spring washer GB93 Φ38×10×3	2037401	1
8	Screw GB5783 M10X25	6000184	2
9	Complete axle	2032901	1
10	Bolt GB818/M4X10	6000267	4
11	Thread hub	2042201	1
12	Bolt GB70/M10X160	6000259	1
13	Tower spring	2042801	1
14	Plastic lid	3005013	1
15	Conic NO.1	2033401	1
16	Conic NO.2	2033501	1
17	Conic NO.3	2033601	1
18	Conic NO.4	2033701	1
19	Hex nut GB41 M10	6000336	5
20	Copper backing	6000159	4
21	Allen wrench	6000169	1
22	Retaining ring	2067389	1
23	Support	2034001	1
24	Position pick-up board	5000401	1

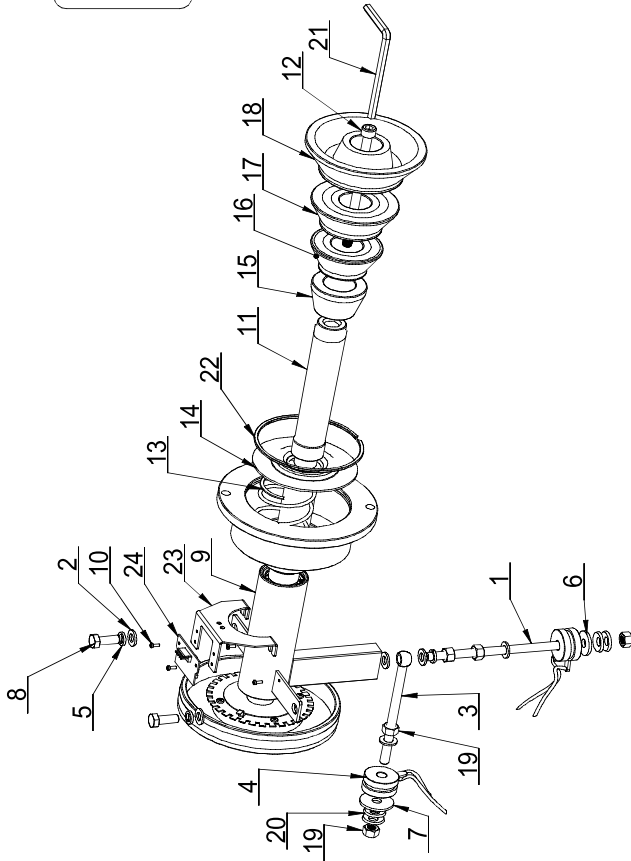

ITEM NO	DESCRIPTION	PART NO.	Q'TY
1	Sleeve	2064812	1
2	Slide bearing	2064398	1
3	Support	2067562	1
4	Aluminum ruler rod	2046301	1
5	Footage number	5001388	1
6	Circuit board-support	2067563	1
7	Distance pick-up board	2067439	1
8	Potentiometer RV24/202	4004471	1
9	Complete ruler head	2065780	1
10	Potentiometer support	2066172	1
11	Grating ruler	2067437	1
12	Bolt M3X10	6000375	1
13	Hex nut GB41 M3	6000124	1
14	Bolt GB845 ST4.2X16	6000160	2
15	Bolt GB80 M6X12	6000230	2
16	Bolt GB70 M6X20	6000114	1
17	Bolt GB818M5x16	6000271	2
18	Tension spring	2034401	1

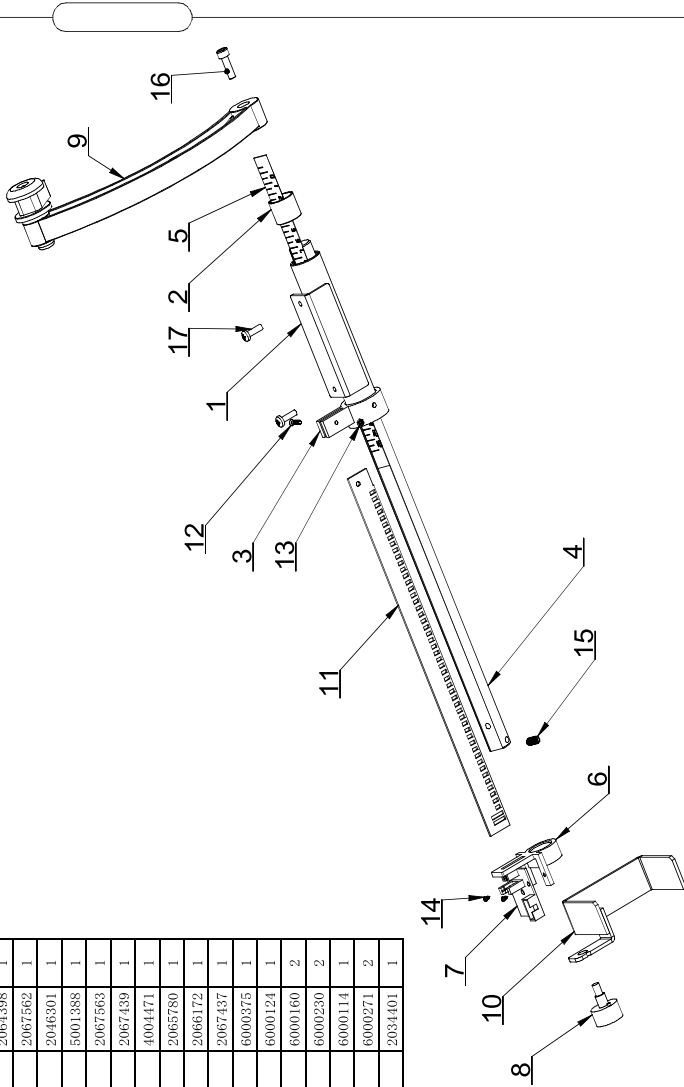



ITEM NO	DESCRIPTION	PART NO.	Q'TY
1	Fixed plate	2064782	1
2	Electric power board	5001321	1
3	Support	4004380	4
4	Resistor	5001350	1
5	Bolt GB818 M5X16	6000271	2
6	Hex nut GB41 M5	6000125	2

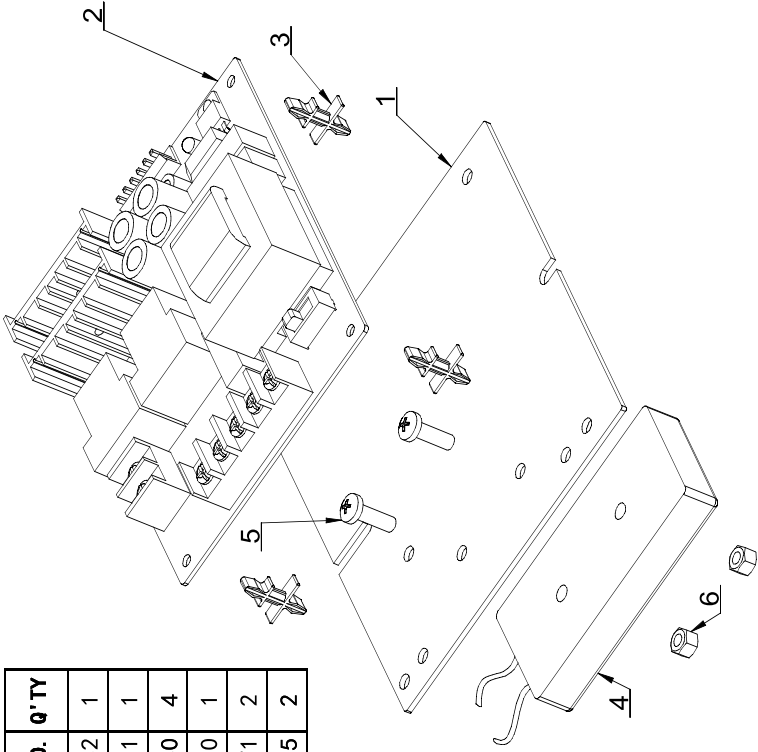

ITEM NO	DESCRIPTION	PART NO.	Q'TY
1	2#/Head with Tools Tray	3005248	1
2	Fix Plate	2065290	1
3	Computer bard	5001319	1
4	Display mask	5001378	1
5	Bolt GB819/M3X10	6000375	5
6	Bolt GB818/ M5X16	6000271	2

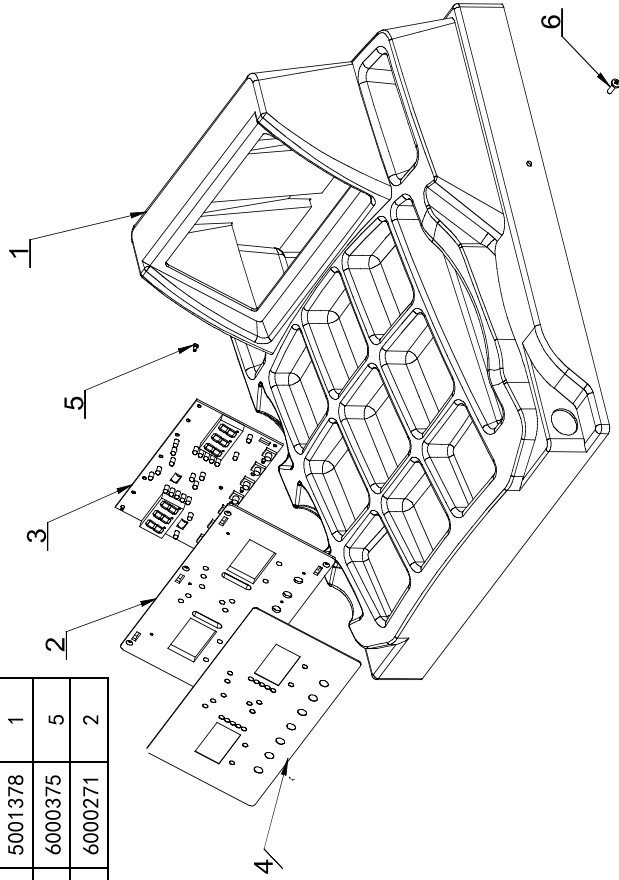

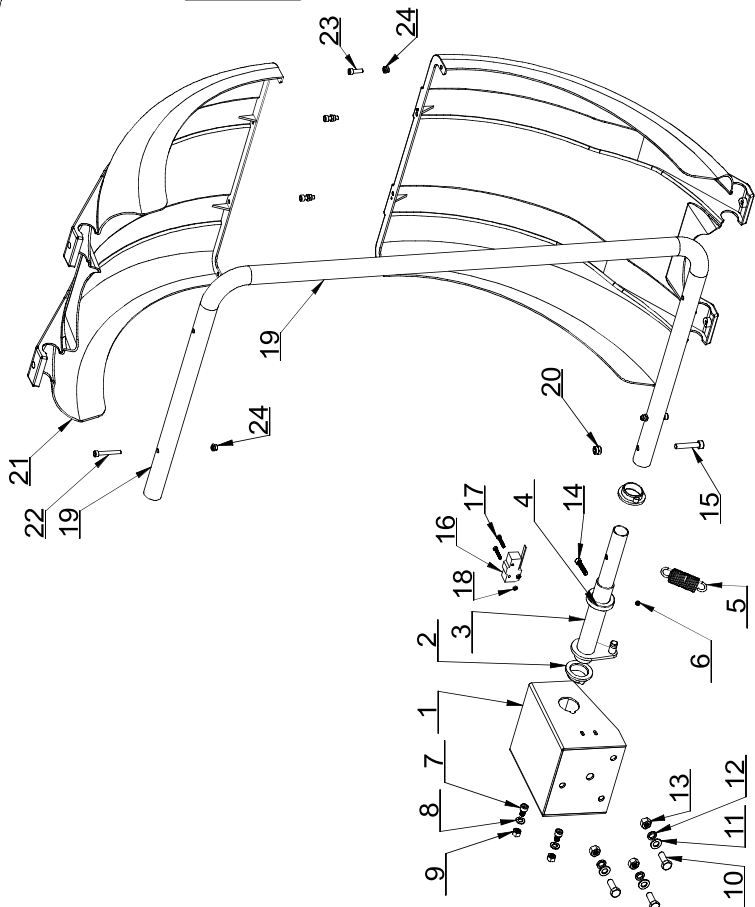

ITEM NO	DESCRIPTION	PART NO.	Q'TY
1	Protection box	2043701	1
2	Plastic ferrule	3002301	2
3	Shaft	2036601	1
4	Ferrule	2034201	1
5	Tension spring	2053501	1
6	Bolt GB80/M6X10	6000130	1
7	Bolt GB70/M8X20	6000102	2
8	washer GB95/Ø8	6000142	2
9	Hex nut GB41 M8	6000127	2
10	Screw GB5783 M10X25	6000184	3
11	washer GB95/Ø10	6000134	3
12	Spring washer GB93/Ø10	6000197	3
13	Hex nut GB41 M10	6000123	3
14	Bolt GB5783 M6X35	6000207	1
15	Bolt GB70 M8X45	6000435	1
16	Micro switch	4004436	1
17	Bolt GB818 M4X30	6000430	2
18	Hex nut GB41 M4	6000341	2
19	Bend pipe	2033301	1
20	Hex nut M8	6000127	1
21	Plastic cover (Ø716)	3002501	2
22	Bolt GB70 M6X45	6000435	2
23	Bolt GB70 M6X20	6000114	4
24	Hex nut M6	6000309	6

2015/0520

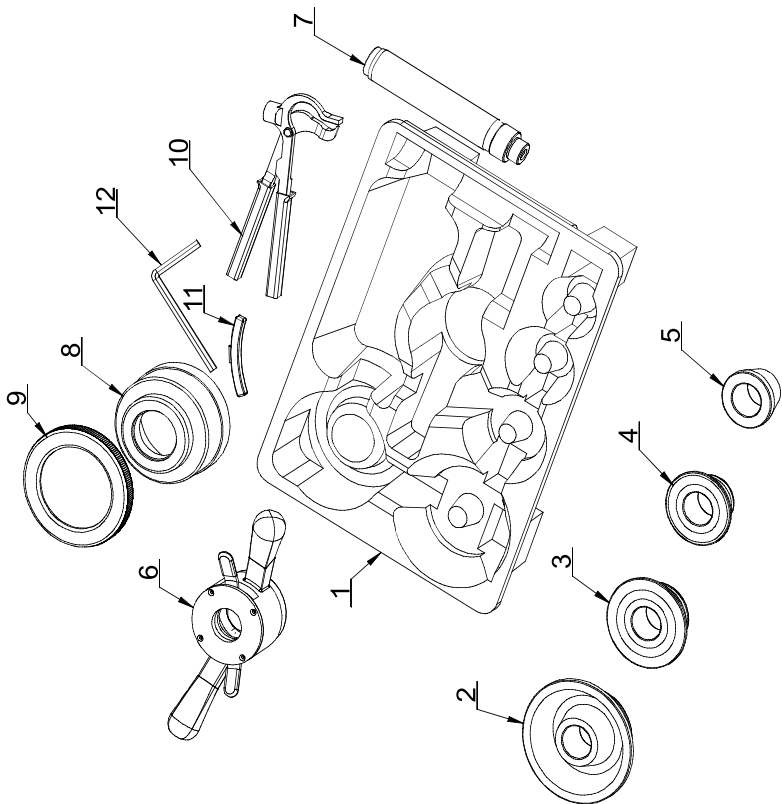

ITEM NO	DESCRIPTION	PART NO.	Q' TY
1	Package box	7000114	1
2	Gonic 4	2033701	1
3	Gonic 3	2033601	1
4	Gonic 2	2033501	1
5	Gonic 1	2033401	1
6	Locking nut	2042901	1
7	Thread rod	2042201	1
8	Plastic bowl	3005018	1
9	Rubber buffer	3005019	1
10	Hammer	4003601	1
11	Counterweight	6000210	1
12	Spanner	6000169	1





